

312E

Hydraulic Excavator



Engine

Engine Model	Cat® C4.4 ACERT™	
Engine Rated Power – ISO 14396	70 kW	94 hp

Drive

Maximum Travel Speed	5.5 km/h
Maximum Drawbar Pull	114 kN

Weight

Minimum Operating Weight	13 200 kg
Maximum Operating Weight	15 700 kg

Introduction

Since its introduction in the 1990s, the 300 Series family of excavators has become the industry standard in general, quarry, and heavy construction applications. The all-new E Series and the 312E will continue that trend-setting standard.

The 312E meets today's European Union Stage IIIB emission standards. It is also built with several new fuel-saving and comfort-enabling features and benefits that will delight owners and operators.

If you are looking for more productivity and comfort, less fuel consumption and emissions, and easier and more sensible serviceability, you will find it in the all-new 312E and the E Series family of excavators.



Contents

Engine	3
Operator Station.....	4
Hydraulics	5
Structures & Undercarriage	6
Front Linkage	7
Work Tools.....	8
Integrated Technologies.....	10
Serviceability	11
Safety	12
Complete Customer Care.....	13
Sustainability	14
Specifications.....	15
Standard Equipment.....	30
Optional Equipment.....	31

Engine

Reduced emissions, economical and reliable performance

Cat® C4.4 ACERT™ Engine

The Cat C4.4 ACERT engine delivers the same level of performance using significantly less fuel than the previous series engine.

Emissions Solution

Equipped to meet European Union Stage IIIB emission standards, the 312E's C4.4 ACERT engine features an after treatment regeneration solution that ensures the machine works as normal with no operator intervention needed.

Biodiesel-Ready Fuel System

The C4.4 ACERT engine is equipped with an electronic-controlled high-pressure fuel system that includes an electric priming pump and three-layer fuel hoses to allow the use of biodiesel (meeting EN 14214) up to B20 (biodiesel 20% mixture).

All non road European Union Stage IIIB diesel engines are required to use only Ultra Low Sulfur Diesel (ULSD) fuels containing 15 mg/kg sulfur or less. Cat® DEO-ULS™ or oils that meet the Cat ECF-3, API CJ-4, and ACEA E9 specification are also required. For further fluid specifications and guidelines, visit: <http://www.cat.com/cda/files/214956/7/SEBU6251-13-secured.pdf>

Cooling System

The cooling system features an air-to-air aftercooler and A/C condenser that tilt up and swing out of the way for easy servicing.

Speed and Power Control

The 312E features speed control to maximize performance while minimizing fuel consumption. Two different power modes are offered: high power mode when you need maximum production; economy mode when you need performance with the lowest fuel consumption. The operator can easily change between modes through the console switch panel to meet the needs for the job at hand – all to help manage and conserve fuel.

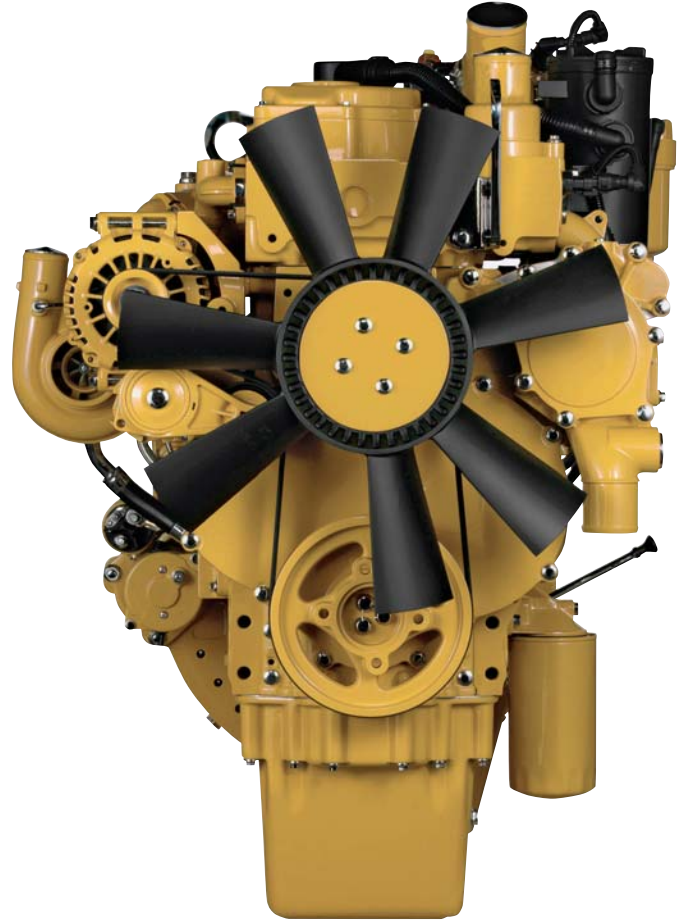

Operator Station

Comfort and convenience to keep people productive



Seats

The seat range includes air suspension, heated, and air cooled options. All seats include a reclining back, upper and lower seat slide adjustments and height and tilt angle adjustments to meet operator needs for comfort and productivity.

Controls

The right and left joystick consoles can be adjusted to meet individual preferences, improving operator comfort and productivity during the course of a day. With the touch of a button, one-touch idle reduces engine speed to help save fuel; touch it again or move the joystick and the machine returns to normal operating level.

Monitor

The 312E is equipped with a 7" LCD (Liquid Crystal Display) monitor (1) that's 40% bigger than the previous model's with higher resolution for better visibility. In addition to an improved keypad and added functionality, it's programmable to provide information in a choice of 44 languages to support today's diverse workforce.

An "Engine Idle Shutdown" setting accessible through the monitor allows owners and operators to specify how long the machine should idle before shutting down the engine, which can save significant amounts of fuel.

The image of the rearview camera is displayed directly on the monitor, which will help keep you focused on the job at hand.

Power Supply

Two 12-volt power supply sockets are located near key storage areas for charging electronic devices such as an MP3 player and cell phone.

Storage

Storage spaces are located in the front, rear, and side consoles. A dedicated space near the auxiliary power supply holds MP3 players and cell phones. The drink holder accommodates large mugs with handles, and a shelf behind the seat stores large lunch or toolboxes.

Automatic Climate Control

The climate control system features five air outlets with positive filtered ventilation, which makes working in the heat and cold much more pleasant.



Hydraulics

Power to move more dirt, rock, and debris with speed and precision

Main Control Valve and Auxiliary Valves

The 312E uses a high-pressure system to tackle the toughest of work in short order. The machine features a highly efficient and simple main control valve to improve fuel consumption; it also allows for greater tool versatility.

Electric Boom Regeneration System

The 312E regenerates the flow of oil from the head end of the boom cylinder to the rod end of the boom cylinder during a boom down operation to save energy, which helps improve fuel efficiency. It is optimized for any dial speed setting being used by the operator, which results in less pressure loss for higher controllability, more productivity, and lower operating costs.

Structures & Undercarriage

Built to work in rugged environments



Frame

The upper frame includes reinforced mountings to support the Roll-Over Protective Structure (ROPS) cab; the lower frame is reinforced to increase component durability.

Undercarriage

Standard and long undercarriage support various work applications. The track rollers are a double solid-pin-type design to improve reliability compared to the single solid-pin-type design. A segmented two-piece guiding guard is now offered to help maintain track alignment and improve performance in multiple applications.

Counterweight

Built with integrated rearview camera housing, the counterweights come with integrated links to enable easy removal for maintenance or shipping.





Front Linkage

Made for high stress and long service life

Booms and Sticks

The 312E is offered with reach and variable angle booms and four stick configurations: R2.1 m, R2.5 m, and R3.0 m (with and without Cat Grade Control). Each boom and stick is built with internal baffle plates for added durability, and each undergoes ultrasound inspection to ensure weld quality and reliability.

Reach configurations balance digging force and bucket capacity. They cover all applications this size of machine was designed to take on such as digging, loading, trenching, and working with hydraulic tools.

Large box-section structures with thick, multi-plate fabrications, castings, and forgings are used in high-stress areas such as the boom nose, boom foot, boom cylinder, and stick foot to improve durability. Also, the front linkage pins' inner bearing surfaces are welded with a self-lubricated bearing used to extend service intervals and increase uptime.

Work Tools

Working as one

An extensive range of Cat Work Tools for the 312E includes buckets, compactors, grapples and hammers. Each is designed to optimize the versatility and performance of your machine.

Quick Couplers

Quick couplers allow one person to change work tools in seconds for maximum performance and flexibility on a job site. One machine can move rapidly from task to task, and a fleet of similarly equipped machines can share a common work tool inventory.

Buckets

Cat buckets are designed as an integral part of the 312E system and feature new geometry for better performance. The leading edge has been repositioned, resulting in more efficient filling and better operator control for greatly improved productivity. Wear coverage in the corners and side cutter and sidebar protector coverage are improved. All benefits are captured in a new bucket line with a new bucket naming convention.



Durability Categories Suitable for Any Situation

Caterpillar offers standard bucket categories for excavators. Each category is based on intended bucket durability when used in recommended applications and materials. Each bucket durability is available as pin-on or can be used with a quick coupler.

General Duty (GD)

GD buckets are for digging in low-impact, low-abrasion material such as dirt, loam, and mixed compositions of dirt and fine gravel.

Severe Duty (SD)

SD buckets are for higher abrasion conditions such as well shot granite and caliche. Red area on bucket image illustrates additional protection against wear as compared to a GD bucket.

Specialty Buckets

In addition to standard bucket categories, specialty bucket styles are available upon request.

Comprehensive Product Support

All Cat Work Tools are backed up by a world-wide network of well-stocked parts depots and highly experienced service and support personnel.

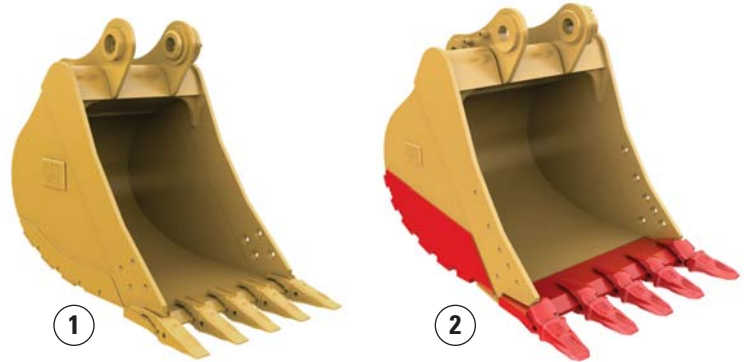

1) General Duty 2) Severe Duty



Integrated Technologies

Solutions that make work easier and more efficient

Cat® Grade Control Depth and Slope

This optional system combines traditional machine control and guidance with standard factory-installed and calibrated components, making the system ready to go to work the moment it leaves the factory. The system utilizes internal front linkage sensors – well protected from the harsh working environment – to give operators real-time bucket tip position information through the cab monitor (1), which minimizes the need and cost for traditional grade checking and enhances job site safety. It also helps the operator complete jobs in fewer cycles, which means less fuel use. Cat dealers can upgrade the system to full three-dimensional control by adding proven Cat AccuGrade™ positioning technologies, including GPS and Universal Total Station (UTS).

Cat Product Link

This optional system is deeply integrated into the machine monitoring system and is designed to help customers improve their overall fleet management effectiveness. Events and diagnostic codes as well as hours, fuel consumption, idle time, machine location, and other detailed information are transmitted to a secure web based application (2 and 3) called VisionLink™, which uses powerful tools to communicate to users and dealers.

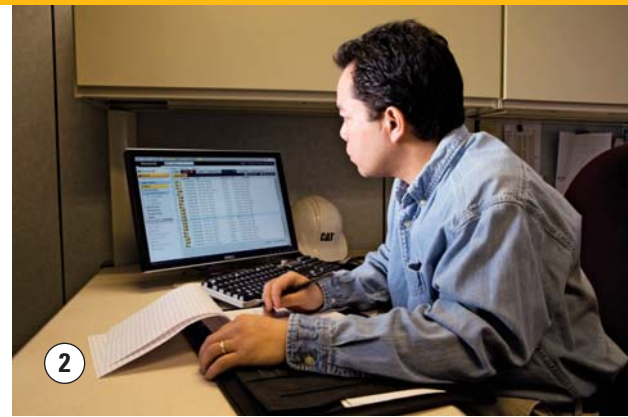

Serviceability

Fast, easy and safe access built in

Service Doors

Wide service doors feature sturdier hinges and latches and a new screen design to help prevent debris entry; a one-piece hood provides easier access to the engine and cooling compartments.

Compartments

The radiator, pump, and air cleaner compartments provide easy access to major components. The fresh air filter is located on the side of the cab to make it easy to reach and replace as needed.

Other Service Benefits

The water separator with water level sensor has a primary fuel filter element located in the pump compartment near ground level; the electric priming pump is mounted before the primary filter base and is easy to service compared to a traditional hand-priming pump.

The fuel tank features a remote drain cock located in the pump compartment to make it easy to remove water and sediment during maintenance.

The engine oil check gauge is situated in front of the engine compartment for easy access, and a uniquely designed drain cock helps prevent spills.



Safety

Features to help protect people



ROPS Cab

The ROPS-certified cab allows an Operator Protective Guard (OPG) to be bolted directly to it.

Sound Proofing

Due to improved sealing and cab roof lining, noise levels inside the cab are significantly lower during machine operation.

Anti-Skid Plates

The surface of the upper structure and the top of the storage box area are covered with anti-skid plates to help prevent service personnel and operators from slipping during maintenance.

Steps, Hand and Guard Rails

Steps on the track frame and storage box along with extended hand and optional guard rails to the upper deck enable operators to securely work on the machine.

Time Delay Lights

When the light switch is on, cab and boom lights will illuminate to enhance visibility after the engine start key has been turned off.

High Intensity Discharge (HID) Lights

Halogen lights are standard, but they can be upgraded to HID for greater visibility.

Windows

The 70/30 split configuration features an upper window equipped with handles on the top and both sides so the operator can slide it to store in the ceiling. The lower window is removable and can be stored on the left wall of the cab shell. The large skylight provides great overhead visibility, excellent natural lighting, and good ventilation. The skylight can be opened completely to become an emergency exit.

Wiper System

A lower wiper is available as an option to maximize visibility in poor weather conditions. The lower wiper motor is integrated to the upper frame so it doesn't obstruct the forward view.

Monitor Warning System

The machine features a buzzer in the monitor that tells customers when critical events like plugged filters or low hydraulic pressure need to be immediately addressed.

Rearview Camera

A standard rearview camera is housed in the counterweight. The image projects through the cab monitor to give the operator a clear view of what is behind the machine.





Complete Customer Care

Service you can count on

Product Support

Cat dealers utilize a worldwide parts network to maximize your machines' uptime. Plus they can help you save money with Cat remanufactured components.

Machine Selection

What are the job requirements and machine attachments? What production is needed? Your Cat dealer can provide recommendations to help you make the right machine choices.

Purchase

Consider financing options and day-to-day operating costs. Look at dealer services that can be included in the machine's cost to yield lower owning and operating costs over time.

Customer Support Agreements

Cat dealers offer a variety of customer support agreements and work with you to develop a plan to meet your specific needs. These plans can cover the entire machine, including attachments, to help protect your investment.

Operation

Improving operating techniques can boost your profits. Your Cat dealer has videos, literature, and other ideas to help you increase productivity. Caterpillar also offers simulators and certified operator training to help maximize the return on your investment.

Replacement

Repair, rebuild, or replace? Your Cat dealer can help you evaluate the cost involved so you can make the best choice for your business.



Sustainability

Generations ahead in every way

- The C4.4 ACERT engine, along with the Cat Clean Emissions Module (CEM), meets EU Stage IIIB emission standards.
- Even when operating in high horsepower and high production applications, the 312E performs a similar amount of work while burning up to 9% less fuel than the previous D Series model. This means more efficiency, less resources consumed, and fewer emissions.
- The 312E has the flexibility of running on either ultra-low-sulfur diesel (ULSD) fuel with 15 mg/kg of sulfur or less or biodiesel (B20) fuel blended with ULSD that meets EN 14214 standards.
- An overfill indicator rises when the fuel tank is full to help service technicians avoid spilling.
- The 312E is built to be rebuilt with major structures and components capable of being remanufactured to reduce waste and replacement costs.
- An efficient engine oil filter eliminates the need for painted metal cans and aluminum top plates. The cartridge-style spin-on housing enables the internal filter to be separated and replaced; the used internal element can be incinerated to help reduce waste.
- The 312E is an efficient, productive machine that's designed to conserve our natural resources for generations ahead.

312E Hydraulic Excavator Specifications

Engine

Engine Model	Cat® C4.4 ACERT™	
Net Power – ISO 14396	70 kW	94 hp
Bore	105 mm	
Stroke	127 mm	
Displacement	4.4 L	

Weights

Minimum Operating Weight* 13 200 kg

Maximum Operating Weight** 15 700 kg

*Long Undercarriage, R2.5, 0.65 m³ bucket and 500 mm shoe.

**Long Undercarriage, R3.0, 0.65 m³ bucket, 770 mm shoe and blade.

Hydraulic System

Main System – Maximum Flow (Total) 254 L/min

Swing System – Maximum Flow 127 L/min

Maximum Pressure – Equipment 30 500 kPa

Maximum Pressure – Travel 35 000 kPa

Maximum Pressure – Swing 23 000 kPa

Pilot System – Maximum Flow 21.9 L/min

Pilot System – Maximum Pressure 4120 kPa

Boom Cylinder – Bore 110 mm

Boom Cylinder – Stroke 1015 mm

Stick Cylinder – Bore 120 mm

Stick Cylinder – Stroke 1197 mm

Bucket Cylinder – Bore 100 mm

Bucket Cylinder – Stroke 939 mm

Drive

Maximum Travel Speed 5.5 km/h

Maximum Drawbar Pull 114 kN

Swing Mechanism

Swing Speed 11.5 rpm

Swing Torque 30.9 kN·m

Service Refill Capacities

Fuel Tank Capacity 250 L

Cooling System 22 L

Engine Oil (with filter) 13.5 L

Swing Drive (each) 2.4 L

Final Drive (each) 3 L

Hydraulic System (including tank) 164 L

Hydraulic Tank 90.6 L

Track

Number of Shoes (each side)

Standard Undercarriage 43 pieces

Long Undercarriage 46 pieces

Number of Track Rollers (each side)

Standard Undercarriage 6 pieces

Long Undercarriage 7 pieces

Number of Carrier Rollers (each side)

Standard Undercarriage 1 piece

Long Undercarriage 2 pieces

Sound Performance

Operator Noise (Closed) – ISO 6396 69 dB(A)

Spectator Noise – ISO 6395 100 dB(A)

- When properly installed and maintained, the cab offered by Caterpillar, when tested with doors and windows closed according to ANSI/SAE J1166 OCT98, meets OSHA and MSHA requirements for operator sound exposure limits in effect at time of manufacture.
- Hearing protection may be needed when operating with an open operator station and cab (when not properly maintained or doors/windows open) for extended periods or in noisy environment.

Standards

Brakes

ROPS Cab ISO 12117-2

Cab/OPG ISO 10262 1998

312E Hydraulic Excavator Specifications

Dimensions

All dimensions are approximate.

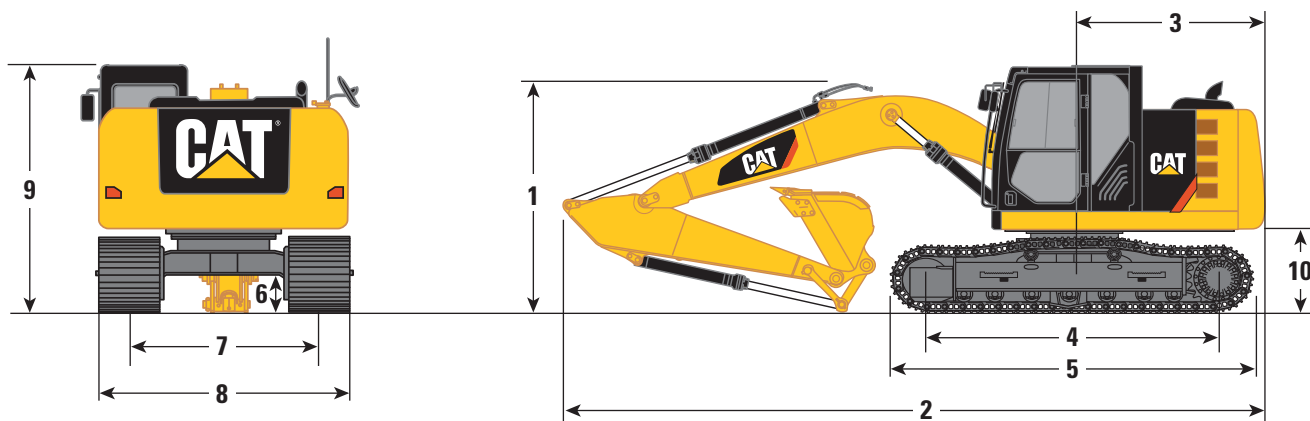

Stick	Reach Boom 4.65 m			Variable Angle Boom	
	R3.0 mm	R2.5 mm	2.1 mm	R2.5 mm	2.1 mm
1 Shipping Height*	3060	3060	3060	3060	3060
Shipping Height at Boom Top	2830	2830	2830	2750	2490
Shipping Height with Guard Rail	3060	3060	3060	3060	3060
Shipping Height with Top Guard	2970	2970	2970	2970	2970
2 Shipping Length					
Standard Undercarriage	7680	7670	7690	7730	7770
Long Undercarriage	7670	7670	7690	7730	7770
Standard Undercarriage with Blade	7900	7890	7910	7950	7990
Long Undercarriage with Blade	7960	7950	7970	8010	8050
3 Tail Swing Radius	2160	2160	2160	2160	2160
4 Length to Center of Rollers					
Standard Undercarriage	2780	2780	2780	2780	2780
Long Undercarriage	3040	3040	3040	3040	3040
5 Track Length					
Standard Undercarriage	3490	3490	3490	3490	3490
Long Undercarriage	3750	3750	3750	3750	3750
6 Ground Clearance	440	440	440	440	440
7 Track Gauge	1990	1990	1990	1990	1990
8 Transport Width					
500 mm Shoes	2490	2490	2490	2490	2490
600 mm Shoes	2590	2590	2590	2590	2590
700 mm Shoes	2690	2690	2690	2690	2690
9 Cab Height	2770	2770	2270	2770	2770
Cab Height with Top Guard	2970	2970	2970	2970	2970
10 Counterweight Clearance**	890	890	890	890	890

*Including shoe lug height.

**Without shoe lug height.

Working Ranges

All dimensions are approximate.

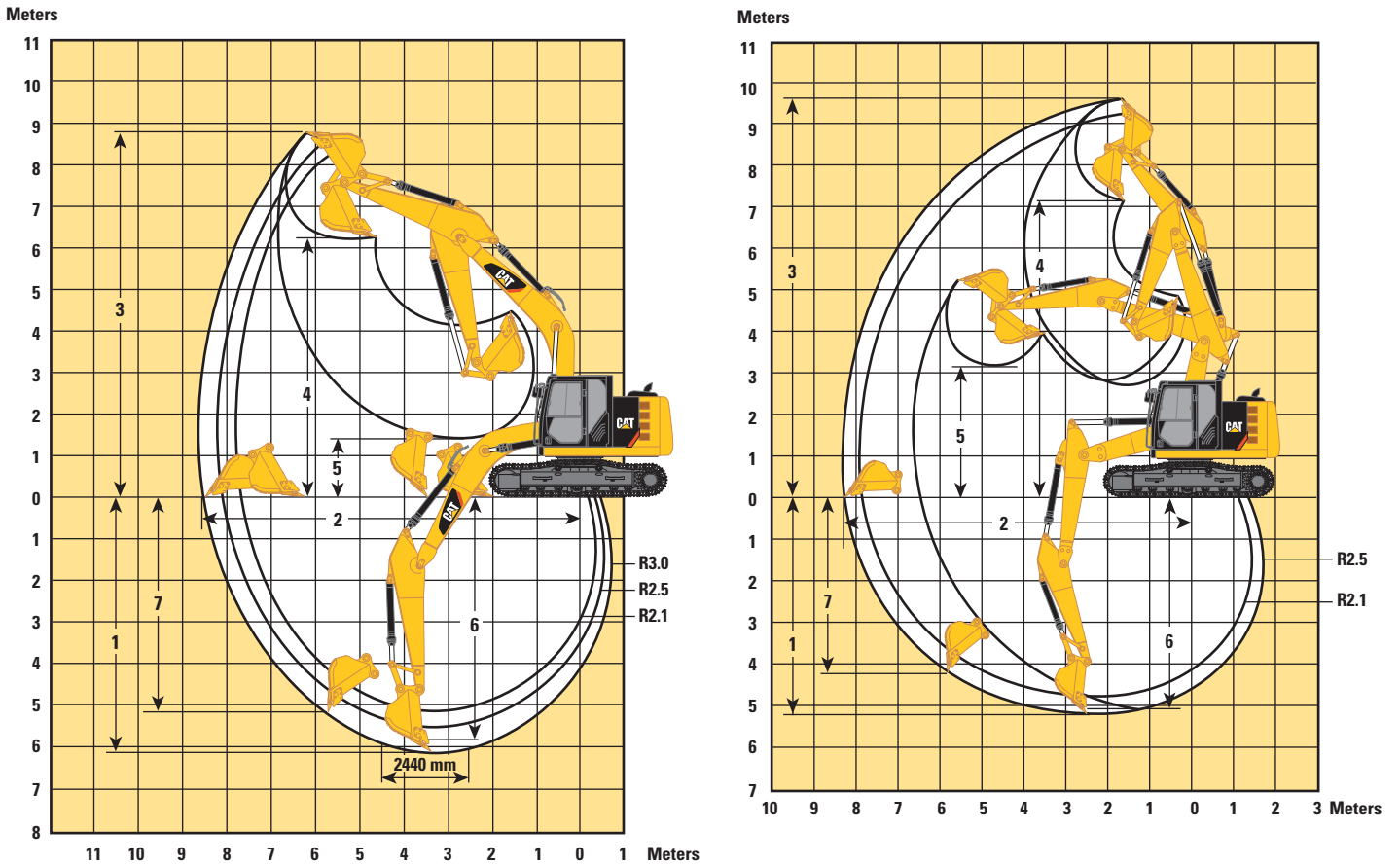

Stick	Reach Boom 4.65 m			Variable Angle Boom	
	R3.0 mm	R2.5 mm	R2.1 mm	R2.5 mm	R2.1 mm
1 Maximum Digging Depth	6040	5540	5140	5210	4820
2 Maximum Reach at Ground Level	8620	8170	7790	8310	7920
3 Maximum Cutting Height	8710	8490	8230	9610	9250
4 Maximum Loading Height	6330	6100	5850	7160	6810
5 Minimum Loading Height	1530	2020	2420	2750	3110
6 Maximum Depth Cut for 2440 mm Level Bottom	5860	5330	4900	5090	4680
7 Maximum Vertical Wall Digging Depth	5200	4840	4380	4260	3840

312E Hydraulic Excavator Specifications

Operating Weight and Ground Pressure

Standard Undercarriage without Blade

	700 mm		600 mm		500 mm	
	Triple Grouser Shoes		Triple Grouser Shoes		Triple Grouser Shoes	
	kg	kPa	kg	kPa	kg	kPa
Reach Boom – 4.65 m						
R3.0	13 700	31.7	13 500	36.4	13 200	42.7
R2.5	13 600	31.4	13 400	36.1	13 200	42.7
R2.1	13 600	31.4	13 400	36.1	13 200	42.7
Variable Angle Boom						
R2.5	14 300	33.1	14 100	38.0	13 900	45.0
R2.1	14 300	33.1	14 100	38.0	13 900	45.0

Long Undercarriage without Blade

	700 mm		600 mm		500 mm	
	Triple Grouser Shoes		Triple Grouser Shoes		Triple Grouser Shoes	
	kg	kPa	kg	kPa	kg	kPa
Reach Boom – 4.65 m						
R3.0	14 100	30.0	13 800	34.2	13 500	40.2
R2.5	14 000	29.8	13 700	34.1	13 500	40.1
R2.1	14 000	29.8	13 730	34.1	13 480	40.1
Variable Angle Boom						
R2.5	14 700	31.3	14 400	35.7	14 200	42.3
R2.1	14 700	31.3	14 400	35.7	14 200	42.3

Standard Undercarriage with Blade

	700 mm		600 mm		500 mm	
	Triple Grouser Shoes		Triple Grouser Shoes		Triple Grouser Shoes	
	kg	kPa	kg	kPa	kg	kPa
Reach Boom – 4.65 m						
R3.0	14 500	33.5	14 300	38.6	14 000	45.3
R2.5	14 400	33.3	14 200	38.3	14 000	45.3
R2.1	14 500	33.5	14 200	38.3	14 000	45.3
Variable Angle Boom						
R2.5	15 200	35.1	14 900	40.2	14 700	47.6
R2.1	15 200	35.1	14 900	40.2	14 700	47.6

Long Undercarriage with Blade

	700 mm		600 mm		500 mm	
	Triple Grouser Shoes		Triple Grouser Shoes		Triple Grouser Shoes	
	kg	kPa	kg	kPa	kg	kPa
Reach Boom – 4.65 m						
R3.0	14 900	31.7	14 600	36.2	14 400	42.9
R2.5	14 800	31.5	14 500	36.0	14 300	42.6
R2.1	14 800	31.5	14 500	36.0	14 300	42.6
Variable Angle Boom						
R2.5	15 500	33.0	15 200	37.7	15 000	44.7
R2.1	15 530	33.0	15 250	37.8	15 000	44.7

All weights are rounded up to nearest 100 kg including General Duty 0.65 m³ bucket (470 kg).

Variable Angle Boom weights include AUX Lines.

Major Component Weights

	kg
Base Machine (with boom cylinder, without counterweight, front linkage and track)	5120
Undercarriage	
Long Undercarriage	2600
Standard Undercarriage	2380
Counterweight – 2.2 mt	2200
Boom (includes lines, pins and stick cylinder)	
Reach Boom – 4.65 m	1010
Variable Angle Boom	1740
Stick (includes lines, pins, bucket cylinder, and bucket linkage)	
R3.0	560
R2.5	480
R2.1	490
Track Shoe (Standard/per one track)	
500 mm Triple Grouser	1460
600 mm Triple Grouser	1700
700 mm Triple Grouser	1960
Track Shoe (Long/per one track)	
500 mm Triple Grouser	1560
600 mm Triple Grouser	1820
700 mm Triple Grouser	2100
Blade	
2500 mm	810
2600 mm	810
2700 mm	820

All weights are rounded up to nearest 10 kg except for quick coupler and buckets.

Base machine includes 75 kg operator weight, 90% fuel weight, and undercarriage with center guard.

Bucket and Stick Forces

Stick	Reach Boom 4.65 m			Variable Angle Boom	
	R3.0 kN	R2.5 kN	R2.1 kN	R2.5 kN	R2.1 kN
General Duty Bucket					
Bucket Digging Force (ISO)	95	95	95	95	95
Stick Digging Force (ISO)	58	65	74	65	74
Heavy Duty Bucket					
Bucket Digging Force (ISO)	95	95	95	95	95
Stick Digging Force (ISO)	58	65	74	65	74
Severe Duty Bucket					
Bucket Digging Force (ISO)	95	95	95	95	95
Stick Digging Force (ISO)	58	65	74	65	74

312E Hydraulic Excavator Specifications

312E Reach Boom Lift Capacities



Load Point Height



Load at Maximum Reach



Load Radius Over Front



Load Radius Over Side

Boom – 4.65 m

Counterweight – 2.2 mt

Bucket – None

Stick – R3.0

Shoes – 700 mm triple grouser with step

		1.5 m		3.0 m		4.5 m		6.0 m		7.5 m				m
7.5 m	kg											*2550	*2550	4.37
6.0 m	kg											*2100	*2100	5.95
4.5 m	kg							*3150	2500			*2000	*2000	6.86
3.0 m	kg					*3900	3750	3350	2450			*2000	1750	7.35
1.5 m	kg			*7600	6400	*4950	3500	3250	2350	*2150	1650	*2050	1650	7.52
Ground Line	kg			*7850	5950	4750	3300	3150	2250			*2300	1650	7.38
-1.5 m	kg	*4500	*4500	9150	5850	4650	3200	3100	2200			2550	1800	6.91
-3.0 m	kg	*7500	*7500	*8550	5900	4650	3200	3100	2200			3100	2200	6.04
-4.5 m	kg			*6450	6100	*4050	3350					*4000	3350	4.53

Boom – 4.65 m

Counterweight – 2.2 mt

Bucket – None

Stick – R2.5

Shoes – 700 mm triple grouser with step

		1.5 m		3.0 m		4.5 m		6.0 m				m
6.0 m	kg					*3350	*3350			*2450	*2450	5.37
4.5 m	kg					*3550	*3550	3400	2500	*2250	2250	6.37
3.0 m	kg			*5850	*5850	*4350	3750	3350	2450	*2250	1950	6.90
1.5 m	kg			*8450	6250	4950	3500	3250	2350	*2350	1850	7.08
Ground Line	kg			*6900	5950	4800	3350	3150	2250	*2600	1850	6.93
-1.5 m	kg	*4900	*4900	*9250	5950	4700	3250	3150	2250	2850	2050	6.42
-3.0 m	kg	*8750	*8750	*8100	6000	4750	3300			3600	2550	5.47

Boom – 4.65 m

Counterweight – 2.2 mt

Bucket – None

Stick – R2.1

Shoes – 700 mm triple grouser with step

		1.5 m		3.0 m		4.5 m		6.0 m				m
6.0 m	kg					*3800	*3800			*3000	*3000	4.87
4.5 m	kg					*3900	3850			*2750	2450	5.95
3.0 m	kg			*6600	*6600	*4650	3650	3300	2400	*2700	2100	6.51
1.5 m	kg					4900	3450	3200	2300	2750	1950	6.70
Ground Line	kg			*6250	5900	4750	3300	3150	2250	2800	2000	6.54
-1.5 m	kg	*5300	*5300	*8900	5900	4700	3250	3150	2250	3150	2250	6.01
-3.0 m	kg			*7500	6050	4750	3300			4150	2900	4.98

*Indicates that the load is limited by hydraulic lifting capacity rather than tipping load. The above loads are in compliance with hydraulic excavator lift capacity standard ISO 10567:2007. They do not exceed 87% of hydraulic lifting capacity or 75% of tipping load. Weight of all lifting accessories must be deducted from the above lifting capacities. Lifting capacities are based on the machine standing on a firm, uniform supporting surface. The use of a work tool attachment point to handle/lift objects, could affect the machine lift performance.

Always refer to the appropriate Operation and Maintenance Manual for specific product information.

312E Reach Boom Lift Capacities



Load Point Height



Load at Maximum Reach



Load Radius Over Front



Load Radius Over Side















Boom – 4.65 m

Counterweight – 2.2 mt

Bucket – None

Stick – R3.0

Shoes – 500 mm triple grouser

		1.5 m		3.0 m		4.5 m		6.0 m		7.5 m				m
														
7.5 m	kg											*2550	*2550	4.37
6.0 m	kg											*2100	*2100	5.95
4.5 m	kg							*3150	2450			*2000	1950	6.86
3.0 m	kg					*3900	3650	3250	2350			*2000	1700	7.35
1.5 m	kg			*7600	6200	4850	3400	3150	2250	*2150	1600	*2050	1600	7.52
Ground Line	kg			*7850	5750	4600	3200	3000	2150			2250	1600	7.38
-1.5 m	kg	*4500	*4500	8850	5650	4500	3100	2950	2100			2450	1750	6.91
-3.0 m	kg	*7500	*7500	*8550	5700	4500	3100	3000	2100			2950	2100	6.04
-4.5 m	kg			*6450	5900	*4050	3250					*4000	3200	4.53













Boom – 4.65 m

Counterweight – 2.2 mt

Bucket – None

Stick – R2.5

Shoes – 500 mm triple grouser

		1.5 m		3.0 m		4.5 m		6.0 m				m
												
6.0 m	kg					*3350	*3350			*2450	*2450	5.37
4.5 m	kg					*3550	*3550	3300	2400	*2250	2200	6.37
3.0 m	kg			*5850	*5850	*4350	3600	3250	2350	*2250	1900	6.90
1.5 m	kg			*8450	6050	4800	3400	3150	2250	*2350	1800	7.08
Ground Line	kg			*6900	5750	4600	3200	3050	2200	2500	1800	6.93
-1.5 m	kg	*4900	*4900	8950	5750	4550	3150	3000	2150	2750	2000	6.42
-3.0 m	kg	*8750	*8750	*8100	5850	4600	3200			3500	2500	5.47













Boom – 4.65 m

Counterweight – 2.2 mt

Bucket – None

Stick – R2.1

Shoes – 500 mm triple grouser

		1.5 m		3.0 m		4.5 m		6.0 m				m
												
6.0 m	kg					*3800	3800			*3000	*3000	4.87
4.5 m	kg					*3900	3750			*2750	2400	5.95
3.0 m	kg			*6600	6550	*4650	3550	3200	2300	*2700	2050	6.51
1.5 m	kg					4750	3300	3100	2250	2650	1900	6.70
Ground Line	kg			*6250	5700	4550	3200	3050	2150	2700	1950	6.54
-1.5 m	kg	*5300	*5300	*8900	5700	4550	3150	3050	2150	3000	2150	6.01
-3.0 m	kg			*7500	5850	4600	3200			4000	2850	4.98

*Indicates that the load is limited by hydraulic lifting capacity rather than tipping load. The above loads are in compliance with hydraulic excavator lift capacity standard ISO 10567:2007. They do not exceed 87% of hydraulic lifting capacity or 75% of tipping load. Weight of all lifting accessories must be deducted from the above lifting capacities. Lifting capacities are based on the machine standing on a firm, uniform supporting surface. The use of a work tool attachment point to handle/lift objects, could affect the machine lift performance.

Always refer to the appropriate Operation and Maintenance Manual for specific product information.

312E Hydraulic Excavator Specifications

312E L Reach Boom Lift Capacities



Load Point Height



Load at Maximum Reach



Load Radius Over Front



Load Radius Over Side

Boom – 4.65 m

Counterweight – 2.2 mt

Bucket – None

Stick – R3.0

Shoes – 700 mm triple grouser with step

		1.5 m		3.0 m		4.5 m		6.0 m		7.5 m				m
7.5 m	kg											*2550	*2550	4.37
6.0 m	kg											*2100	*2100	5.95
4.5 m	kg							*3150	2550			*2000	*2000	6.86
3.0 m	kg					*3900	3850	*3450	2500			*2000	1800	7.35
1.5 m	kg			*7600	6550	*4950	3600	3700	2400	*2150	1700	*2050	1700	7.52
Ground Line	kg			*7850	6100	5550	3400	3600	2300			*2300	1700	7.38
-1.5 m	kg	*4500	*4500	*9350	6000	5450	3300	3550	2250			*2700	1850	6.91
-3.0 m	kg	*7500	*7500	*8550	6050	5450	3300	3600	2250			3550	2250	6.04
-4.5 m	kg			*6450	6250	*4050	3450					*4000	3400	4.53

Boom – 4.65 m

Counterweight – 2.2 mt

Bucket – None

Stick – R2.5

Shoes – 700 mm triple grouser with step

		1.5 m		3.0 m		4.5 m		6.0 m				m
6.0 m	kg					*3350	*3350			*2450	*2450	5.37
4.5 m	kg					*3550	*3550	*3550	2550	*2250	*2250	6.37
3.0 m	kg			*5850	*5850	*4350	3800	*3750	2500	*2250	2000	6.90
1.5 m	kg			*8450	6400	*5350	3600	3750	2400	*2350	1900	7.08
Ground Line	kg			*6900	6100	5550	3400	3650	2300	*2600	1900	6.93
-1.5 m	kg	*4900	*4900	*9250	6100	5500	3350	3600	2300	*3100	2100	6.42
-3.0 m	kg	*8750	*8750	*8100	6150	*5500	3400			4150	2650	5.47

Boom – 4.65 m

Counterweight – 2.2 mt

Bucket – None

Stick – R2.1

Shoes – 700 mm triple grouser with step

		1.5 m		3.0 m		4.5 m		6.0 m				m
6.0 m	kg					*3800	*3800			*3000	*3000	4.87
4.5 m	kg					*3900	*3900			*2750	2500	5.95
3.0 m	kg			*6600	*6600	*4650	3750	3800	2450	*2700	2150	6.51
1.5 m	kg					*5550	3500	3700	2350	*2850	2000	6.70
Ground Line	kg			*6250	6050	5500	3350	3600	2300	*3200	2050	6.54
-1.5 m	kg	*5300	*5300	*8900	6050	5500	3350	3600	2300	3600	2300	6.01
-3.0 m	kg			*7500	6200	*5100	3400			*4350	3000	4.98

*Indicates that the load is limited by hydraulic lifting capacity rather than tipping load. The above loads are in compliance with hydraulic excavator lift capacity standard ISO 10567:2007. They do not exceed 87% of hydraulic lifting capacity or 75% of tipping load. Weight of all lifting accessories must be deducted from the above lifting capacities. Lifting capacities are based on the machine standing on a firm, uniform supporting surface. The use of a work tool attachment point to handle/lift objects, could affect the machine lift performance.

Always refer to the appropriate Operation and Maintenance Manual for specific product information.

312E L Reach Boom Lift Capacities



Load Point Height



Load at Maximum Reach



Load Radius Over Front



Load Radius Over Side

Boom – 4.65 m

Counterweight – 2.2 mt

Bucket – None

Stick – R3.0

Shoes – 500 mm triple grouser

		1.5 m		3.0 m		4.5 m		6.0 m		7.5 m				m
7.5 m	kg											*2550	*2550	4.37
6.0 m	kg											*2100	*2100	5.95
4.5 m	kg							*3150	2500			*2000	2000	6.86
3.0 m	kg					*3900	3750	*3450	2400			*2000	1750	7.35
1.5 m	kg			*7600	6350	*4950	3500	3600	2300	*2150	1650	*2050	1650	7.52
Ground Line	kg			*7850	5900	5350	3300	3500	2200			*2300	1650	7.38
-1.5 m	kg	*4500	*4500	*9350	5750	5250	3200	3400	2150			*2700	1800	6.91
-3.0 m	kg	*7500	*7500	*8550	5800	5250	3200	3450	2200			3400	2150	6.04
-4.5 m	kg			*6450	6000	*4050	3300					*4000	3300	4.53

Boom – 4.65 m

Counterweight – 2.2 mt

Bucket – None

Stick – R2.5

Shoes – 500 mm triple grouser

		1.5 m		3.0 m		4.5 m		6.0 m				m
6.0 m	kg					*3350	*3350			*2450	*2450	5.37
4.5 m	kg					*3550	*3550	*3550	2450	*2250	2250	6.37
3.0 m	kg			*5850	*5850	*4350	3700	3700	2400	*2250	1950	6.90
1.5 m	kg			*8450	6200	*5350	3450	3600	2300	*2350	1800	7.08
Ground Line	kg			*6900	5900	5400	3300	3500	2250	*2600	1850	6.93
-1.5 m	kg	*4900	*4900	*9250	5850	5300	3250	3500	2200	*3100	2000	6.42
-3.0 m	kg	*8750	*8750	*8100	5950	5350	3250			4000	2550	5.47

Boom – 4.65 m

Counterweight – 2.2 mt

Bucket – None

Stick – R2.1

Shoes – 500 mm triple grouser

		1.5 m		3.0 m		4.5 m		6.0 m				m
6.0 m	kg					*3800	*3800			*3000	*3000	4.87
4.5 m	kg					*3900	3800			*2750	2450	5.95
3.0 m	kg			*6600	*6600	*4650	3600	3650	2350	*2700	2100	6.51
1.5 m	kg					5500	3400	3550	2300	*2850	1950	6.70
Ground Line	kg			*6250	5850	5350	3250	3500	2200	3100	2000	6.54
-1.5 m	kg	*5300	*5300	*8900	5850	5300	3200	3500	2200	3500	2200	6.01
-3.0 m	kg			*7500	6000	*5100	3300			*4350	2900	4.98

*Indicates that the load is limited by hydraulic lifting capacity rather than tipping load. The above loads are in compliance with hydraulic excavator lift capacity standard ISO 10567:2007. They do not exceed 87% of hydraulic lifting capacity or 75% of tipping load. Weight of all lifting accessories must be deducted from the above lifting capacities. Lifting capacities are based on the machine standing on a firm, uniform supporting surface. The use of a work tool attachment point to handle/lift objects, could affect the machine lift performance.

Always refer to the appropriate Operation and Maintenance Manual for specific product information.

312E Hydraulic Excavator Specifications

312E Reach Boom Lift Capacities



Load Point Height



Load at Maximum Reach



Load Radius Over Front



Load Radius Over Side

Boom – 4.65 m

Counterweight – 2.2 mt

Bucket – None

Stick – R3.0

Shoes – 600 mm triple grouser – Blade Down

		1.5 m		3.0 m		4.5 m		6.0 m		7.5 m				m
7.5 m	kg											*2550	*2550	4.37
6.0 m	kg											*2100	*2100	5.95
4.5 m	kg							*3150	2850			*2000	*2000	6.86
3.0 m	kg					*3900	*3900	*3450	2800			*2000	*2000	7.35
1.5 m	kg			*7600	7500	*4950	4050	*3950	2650	*2150	1900	*2050	1900	7.52
Ground Line	kg			*7850	7000	*5750	3850	*4350	2550			*2300	1950	7.38
-1.5 m	kg	*4500	*4500	*9350	6900	*6100	3750	*4500	2500			*2700	2100	6.91
-3.0 m	kg	*7500	*7500	*8550	6950	*5750	3750	*3950	2550			*3600	2500	6.04
-4.5 m	kg			*6450	*6450	*4050	3900					*4000	3850	4.53

Boom – 4.65 m

Counterweight – 2.2 mt

Bucket – None

Stick – R2.5

Shoes – 600 mm triple grouser – Blade Down

		1.5 m		3.0 m		4.5 m		6.0 m				m
6.0 m	kg					*3350	*3350			*2450	*2450	5.37
4.5 m	kg					*3550	*3550	*3550	2850	*2250	*2250	6.37
3.0 m	kg			*5850	*5850	*4350	4250	*3750	2750	*2250	2250	6.90
1.5 m	kg			*8450	7350	*5350	4000	*4200	2650	*2350	2100	7.08
Ground Line	kg			*6900	*6900	*6000	3850	*4500	2600	*2600	2150	6.93
-1.5 m	kg	*4900	*4900	*9250	7000	*6150	3800	*4500	2550	*3100	2350	6.42
-3.0 m	kg	*8750	*8750	*8100	7100	*5500	3800			*4200	2950	5.47

Boom – 4.65 m

Counterweight – 2.2 mt

Bucket – None

Stick – R2.1

Shoes – 600 mm triple grouser – Blade Down

		1.5 m		3.0 m		4.5 m		6.0 m				m
6.0 m	kg					*3800	*3800			*3000	*3000	4.87
4.5 m	kg					*3900	*3900			*2750	*2750	5.95
3.0 m	kg			*6600	*6600	*4650	4200	*3950	2750	*2700	2400	6.51
1.5 m	kg					*5550	3950	*4300	2650	*2850	2250	6.70
Ground Line	kg			*6250	*6250	*6100	3800	*4550	2550	*3200	2300	6.54
-1.5 m	kg	*5300	*5300	*8900	6950	*6050	3750	*4000	2550	*3900	2550	6.01
-3.0 m	kg			*7500	7100	*5100	3850			*4350	3350	4.98

*Indicates that the load is limited by hydraulic lifting capacity rather than tipping load. The above loads are in compliance with hydraulic excavator lift capacity standard ISO 10567:2007. They do not exceed 87% of hydraulic lifting capacity or 75% of tipping load. Weight of all lifting accessories must be deducted from the above lifting capacities. Lifting capacities are based on the machine standing on a firm, uniform supporting surface. The use of a work tool attachment point to handle/lift objects, could affect the machine lift performance.

Always refer to the appropriate Operation and Maintenance Manual for specific product information.

312E L Reach Boom Lift Capacities



Load Point Height



Load at Maximum Reach



Load Radius Over Front



Load Radius Over Side

Boom – 4.65 m

Counterweight – 2.2 mt

Bucket – None

Stick – R3.0

Shoes – 600 mm triple grouser – Blade Down

		1.5 m		3.0 m		4.5 m		6.0 m		7.5 m				m
7.5 m	kg											*2550	*2550	4.37
6.0 m	kg											*2100	*2100	5.95
4.5 m	kg							*3150	2950			*2000	*2000	6.86
3.0 m	kg					*3900	*3900	*3450	2850			*2000	*2000	7.35
1.5 m	kg			*7600	*7600	*4950	4150	*3950	2750	*2150	1950	*2050	1950	7.52
Ground Line	kg			*7850	7200	*5750	3950	*4350	2650			*2300	2000	7.38
-1.5 m	kg	*4500	*4500	*9350	7050	*6100	3850	*4500	2600			*2700	2150	6.91
-3.0 m	kg	*7500	*7500	*8550	7100	*5750	3850	*3950	2600			*3600	2600	6.04
-4.5 m	kg			*6450	*6450	*4050	4000					*4000	3950	4.53

Boom – 4.65 m

Counterweight – 2.2 mt

Bucket – None

Stick – R2.5

Shoes – 600 mm triple grouser – Blade Down

		1.5 m		3.0 m		4.5 m		6.0 m				m
6.0 m	kg					*3350	*3350			*2450	*2450	5.37
4.5 m	kg					*3550	*3550	*3550	2900	*2250	*2250	6.37
3.0 m	kg			*5850	*5850	*4350	*4350	*3750	2850	*2250	*2250	6.90
1.5 m	kg			*8450	7550	*5350	4100	*4200	2750	*2350	2150	7.08
Ground Line	kg			*6900	*6900	*6000	3950	*4500	2650	*2600	2200	6.93
-1.5 m	kg	*4900	*4900	*9250	7150	*6150	3900	*4500	2650	*3100	2400	6.42
-3.0 m	kg	*8750	*8750	*8100	7250	*5500	3900			*4200	3000	5.47

Boom – 4.65 m

Counterweight – 2.2 mt

Bucket – None

Stick – R2.1

Shoes – 600 mm triple grouser – Blade Down

		1.5 m		3.0 m		4.5 m		6.0 m				m
6.0 m	kg					*3800	*3800			*3000	*3000	4.87
4.5 m	kg					*3900	*3900			*2750	*2750	5.95
3.0 m	kg			*6600	*6600	*4650	4300	*3950	2800	*2700	2450	6.51
1.5 m	kg					*5550	4050	*4300	2700	*2850	2300	6.70
Ground Line	kg			*6250	*6250	*6100	3900	*4550	2650	*3200	2350	6.54
-1.5 m	kg	*5300	*5300	*8900	7150	*6050	3850	*4000	2650	*3900	2650	6.01
-3.0 m	kg			*7500	7300	*5100	3950			*4350	3450	4.98

*Indicates that the load is limited by hydraulic lifting capacity rather than tipping load. The above loads are in compliance with hydraulic excavator lift capacity standard ISO 10567:2007. They do not exceed 87% of hydraulic lifting capacity or 75% of tipping load. Weight of all lifting accessories must be deducted from the above lifting capacities. Lifting capacities are based on the machine standing on a firm, uniform supporting surface. The use of a work tool attachment point to handle/lift objects, could affect the machine lift performance.

Always refer to the appropriate Operation and Maintenance Manual for specific product information.

312E Hydraulic Excavator Specifications

312E Variable Angle Boom Lift Capacities



Load Point Height



Load at Maximum Reach



Load Radius Over Front



Load Radius Over Side

Boom – Variable Angle

Counterweight – 2.2 mt

Bucket – None

Stick – R2.5

Shoes – 500 mm triple grouser – Blade Down

		1.5 m		3.0 m		4.5 m		6.0 m				m
7.5 m	kg			*3050	*3050					*2950	*2950	3.79
6.0 m	kg			*4550	*4550	*2450	*2450			*2350	*2350	5.54
4.5 m	kg			*4800	*4800	*3100	*3100	*2250	*2250	*2200	*2200	6.51
3.0 m	kg	*10 850	*10 850	*4950	*4950	*3550	*3550	*2300	*2300	*2150	2050	7.03
1.5 m	kg	*4650	*4650	*6350	*6350	*4750	3800	*2600	2500	*2250	1900	7.21
Ground Line	kg	*4050	*4050	*6400	*6400	*6050	3550	*2950	2400	*2450	1950	7.06
-1.5 m	kg	*6100	*6100	*8450	6450	*6100	3500	*3400	2400	*2850	2100	6.57
-3.0 m	kg	*11 250	*11 250	*6950	6600	*4450	3550			*3650	2800	5.38

Boom – Variable Angle

Counterweight – 2.2 mt

Bucket – None

Stick – R2.1

Shoes – 500 mm triple grouser – Blade Down

		1.5 m		3.0 m		4.5 m		6.0 m				m
7.5 m	kg									*3800	*3800	2.99
6.0 m	kg			*5150	*5150	*2850	*2850			*2850	*2850	5.04
4.5 m	kg			*5050	*5050	*2700	*2700	*2650	2650	*2600	2550	6.09
3.0 m	kg	*10 500	*10 500	*4900	*4900	*4100	3950	*2750	2550	*2600	2200	6.64
1.5 m	kg			*6900	6700	*5100	3700	*3050	2450	*2700	2050	6.82
Ground Line	kg	*5250	*5250	*5700	*5700	*6450	3500	*3500	2400	*2950	2050	6.67
-1.5 m	kg	*7700	*7700	*7600	6450	*5750	3500	*3850	2400	*3500	2300	6.15
-3.0 m	kg	*14 350	*14 350	*6900	6600	*4500	3600			*4300	3450	4.66

*Indicates that the load is limited by hydraulic lifting capacity rather than tipping load. The above loads are in compliance with hydraulic excavator lift capacity standard ISO 10567:2007. They do not exceed 87% of hydraulic lifting capacity or 75% of tipping load. Weight of all lifting accessories must be deducted from the above lifting capacities. Lifting capacities are based on the machine standing on a firm, uniform supporting surface. VA-cylinder is flexible. The use of a work tool attachment point to handle/lift objects, could affect the machine lift performance.

Always refer to the appropriate Operation and Maintenance Manual for specific product information.

312E L Variable Angle Boom Lift Capacities



Load Point Height



Load at Maximum Reach



Load Radius Over Front



Load Radius Over Side

Boom – Variable Angle

Counterweight – 2.2 mt

Bucket – None

Stick – R2.5

Shoes – 500 mm triple grouser – Blade Down

		1.5 m		3.0 m		4.5 m		6.0 m				m
7.5 m	kg			*3050	*3050					*2950	*2950	3.79
6.0 m	kg			*4550	*4550	*2450	*2450			*2350	*2350	5.54
4.5 m	kg			*4800	*4800	*3100	*3100	*2250	*2250	*2200	*2200	6.51
3.0 m	kg	*10 850	*10 850	*4950	*4950	*3550	*3550	*2300	*2300	*2150	2100	7.03
1.5 m	kg	*4650	*4650	*6350	*6350	*4750	3850	*2600	2550	*2250	1950	7.21
Ground Line	kg	*4050	*4050	*6400	*6400	*6050	3650	*2950	2450	*2450	2000	7.06
-1.5 m	kg	*6100	*6100	*8450	6650	*6100	3600	*3400	2450	*2850	2200	6.57
-3.0 m	kg	*11 250	*11 250	*6950	6750	*4450	3650			*3650	2900	5.38

Boom – Variable Angle

Counterweight – 2.2 mt

Bucket – None

Stick – R2.1

Shoes – 500 mm triple grouser – Blade Down

		1.5 m		3.0 m		4.5 m		6.0 m				m
7.5 m	kg									*3800	*3800	2.99
6.0 m	kg			*5150	*5150	*2850	*2850			*2850	*2850	5.04
4.5 m	kg			*5050	*5050	*2700	*2700	*2650	*2650	*2600	*2600	6.09
3.0 m	kg	*10 500	*10 500	*4900	*4900	*4100	4050	*2750	2650	*2600	2250	6.64
1.5 m	kg			*6900	6900	*5100	3800	*3050	2550	*2700	2100	6.82
Ground Line	kg	*5250	*5250	*5700	*5700	*6450	3600	*3500	2450	*2950	2150	6.67
-1.5 m	kg	*7700	*7700	*7600	6600	*5750	3550	*3850	2450	*3500	2400	6.15
-3.0 m	kg	*14 350	*14 350	*6900	6800	*4500	3700			*4300	3550	4.66

*Indicates that the load is limited by hydraulic lifting capacity rather than tipping load. The above loads are in compliance with hydraulic excavator lift capacity standard ISO 10567:2007. They do not exceed 87% of hydraulic lifting capacity or 75% of tipping load. Weight of all lifting accessories must be deducted from the above lifting capacities. Lifting capacities are based on the machine standing on a firm, uniform supporting surface. VA-cylinder is flexible. The use of a work tool attachment point to handle/lift objects, could affect the machine lift performance.

Always refer to the appropriate Operation and Maintenance Manual for specific product information.

312E Hydraulic Excavator Specifications

Work Tool Offering Guide*

Boom Type	Reach Boom			Variable Angle Boom	
	R3.0	R2.5	R2.1	R2.5	R2.1
Hydraulic Hammer	H110Es H115Es	H110Es H115Es	H110Es H115Es	H110Es H115Es***	H110Es H115Es***
Demolition and Sorting Grapple	G310B (pin-on only)	G310B	G310B		
Mobile Scrap and Demolition Shear	S320B**	S320B**	S320B**	S320B**	S320B**
Compactor (Vibratory Plate)	CVP75	CVP75	CVP75	CVP75	CVP75
Contractors' Grapple	G112B	G112B	G112B	G112B	G112B
Orange Peel Grapple					
Trash Grapple					
Dedicated Quick Coupler					

These work tools are available for the 312E.
Consult your Cat dealer for proper match.

*Matches are dependent on excavator configurations. Consult your Cat dealer for proper work tool match.

**Boom mount.

***Pin-on or CW coupler.

Bucket Specifications and Compatibility

	Width	Capacity	Weight	Fill	Reach Boom			Variable Angle Boom	
	mm	m ³	kg	%	3.0	2.5	2.1	2.5	2.1
Without Quick Coupler									
General Duty (GD)	600	0.31	315	100%	●	●	●	●	●
	750	0.41	362	100%	●	●	●	●	●
	900	0.53	411	100%	●	●	●	●	●
	1000	0.60	436	100%	●	●	●	●	●
	1100	0.68	470	100%	⊙	●	●	⊙	●
	1200	0.76	499	100%	X	X	X	X	X
Heavy Duty (HD)	450	0.20	276	100%	●	●	●	●	●
	1200	0.76	506	100%	X	X	X	X	X
Maximum load pin-on (payload + bucket)				kg	1745	1970	2125	1760	1895
With Quick Coupler (CW20/CW20s)									
General Duty (GD)	450	0.20	300	100%	●	●	●	●	●
	500	0.24	309	100%	●	●	●	●	●
	600	0.31	328	100%	●	●	●	●	●
	750	0.41	374	100%	●	●	●	●	●
	900	0.53	423	100%	●	●	●	●	●
	1000	0.60	452	100%	⊙	●	●	⊙	●
	1100	0.68	482	100%	⊖	⊙	●	⊖	⊙
	1200	0.76	511	100%	○	⊖	⊙	○	⊖
Heavy Duty (HD)	500	0.24	319	100%	●	●	●	●	●
	1200	0.76	511	100%	○	⊖	⊙	○	⊖
Maximum load with coupler (payload + bucket)				kg	1534	1759	1914	1549	1684

The above loads are in compliance with hydraulic excavator standard EN474, they do not exceed 87% of hydraulic lifting capacity or 75% of tipping capacity with front linkage fully extended at ground line with bucket curled.

Capacity based on ISO 7451.

Bucket weight with Long tips.

*Densities with 3.0 m thumb stick do not consider thumb weight.

Maximum Material Density:

- 2100 kg/m³
- ⊙ 1800 kg/m³
- ⊖ 1500 kg/m³
- 1200 kg/m³
- X Not allowed per structures matching guide

Caterpillar recommends using appropriate work tools to maximize the value customers receive from our products. Use of work tools, including buckets, which are outside of Caterpillar's recommendations or specifications for weight, dimensions, flows, pressures, etc. may result in less-than-optimal performance, including but not limited to reductions in production, stability, reliability, and component durability. Improper use of a work tool resulting in sweeping, prying, twisting and/or catching of heavy loads will reduce the life of the boom and stick.

312E Standard Equipment

Standard equipment may vary. Consult your Cat dealer for details.

ENGINE

- C4.4 diesel engine
- Biodiesel capable
- Meets EU Stage IIIB emission standards
- 2300 m altitude capability
- Electric priming pump
- Automatic engine speed control
- Economy and high power modes
- Two-speed travel
- Side-by-side cooling system
- Radial seal air filter
- Primary filter with water separator and water separator indicator
- Secondary filter
- Screen filter in fuel line
- Cold weather battery -25° C

HYDRAULIC SYSTEM

- Regeneration circuit for boom and stick
- Reverse swing dampening valve
- Automatic swing parking brake
- High-performance hydraulic return filter
- Capability of installing HP stackable valve and medium and QC valve
- Capability of installing additional auxiliary pump and circuit
- Boom lowering and stick lowering control device

CAB

- Pressurized operator station with positive filtration
- Sliding upper door window (left-hand cab door)
- Glass-breaking safety hammer
- Removable lower windshield with in cab storage bracket
- Coat hook
- Beverage holder
- Literature holder
- Two 12V stereo speakers
- Storage shelf suitable for lunch or toolbox
- Color LCD display with indicators, filter/fluid change, and working hour information
- Adjustable armrest
- Height adjustable joystick consoles
- Neutral lever (lock out) for all controls
- Travel control pedals with removable hand levers
- Capability of installing two additional pedals
- Two power outlets, 10 amp (total)
- Laminated glass front upper window and tempered other windows
- Sunscreen

UNDERCARRIAGE

- Grease Lubricated Track GLT2, resin seal
- Towing eye on base frame
- Swivel guard

COUNTERWEIGHT

2.2 MT

ELECTRICAL

- 80 amp alternator
- Circuit breaker
- Capability to electrically connect a beacon

LIGHTS

- Halogen boom light (left side)
- Time delay function for boom light and cab light
- Exterior lights integrated into storage box

SECURITY

- Cat one key security system
- Door locks
- Cap locks on fuel and hydraulic tanks
- Lockable external tool/storage box
- Signaling/warning horn
- Secondary engine shutoff switch
- Openable skylight for emergency exit
- Rearview camera

TECHNOLOGY

Product Link

Optional equipment may vary. Consult your Cat dealer for details.

ENGINE

- Quick drains, engine and hydraulic oil
- Electric refueling pump

HYDRAULIC SYSTEM

- Auxiliary hydraulics
- Boom and stick lines
- High-pressure line
- Medium-pressure line
- Cat quick coupler line – high-pressure capable
- Cat Bio hydraulic oil

CAB

- Cab hatch emergency exit
- Seat, high-back air suspension with heater and cooling
- Seat, high-back air suspension with heater
- Seat, high-back mechanical suspension
- Windshield wiper, lower with washer
- Air pre-filter
- Left foot switch
- Left pedal
- Rain protector
- Cab mirror
- Ashtray
- Travel alarm

UNDERCARRIAGE

- 500 mm triple grouser shoes
- 600 mm triple grouser shoes
- 700 mm triple grouser shoes
- Rubber pad for 500 mm triple grouser shoes
- Guard, heavy-duty bottom
- Center track guiding guard
- Segmented (2 piece) track guiding guard
- 2500 mm blade with replaceable cutting edge
- 2600 mm blade with replaceable cutting edge
- 2700 mm blade with replaceable cutting edge

FRONT LINKAGE

- Quick coupler
- Bucket linkage
- 4.65 m reach boom
- VA boom
- 2.1 m stick
- 2.5 m stick
- 3.0 m stick
- 3.0 m stick with Cat Grade Control

LIGHTS

- Working lights, cab mounted with time delay
- HID lights, cab mounted with time delay
- Halogen boom lights (right side)

SECURITY

- FOGS, bolt-on
- Guard rail
- Guard, cab front, mesh

TECHNOLOGY

- Cat Grade Control Depth and Slope

312E Hydraulic Excavator

For more complete information on Cat products, dealer services, and industry solutions, visit us on the web at www.cat.com

© 2012 Caterpillar Inc.
All rights reserved

Materials and specifications are subject to change without notice. Featured machines in photos may include additional equipment. See your Cat dealer for available options.

CAT, CATERPILLAR, SAFETY.CAT.COM, their respective logos, "Caterpillar Yellow" and the "Power Edge" trade dress, as well as corporate and product identity used herein, are trademarks of Caterpillar and may not be used without permission.

AEHQ6663 (02-2012)
(Europe)

